

AUTOMATIC PEDESTRIAN ACCESS



ALLEN
GILGEN DOOR SYSTEMS

OBJECTIVE-ORIENTED

Reliable. Secure. Convenient.

Open up doors for your visitors. Provide a friendly reception based on ease and simplicity of access.



AUTOMATIC PEDESTRIAN ACCESS

- 2 Objective-oriented
- 4 Creative design
- 6 Automatic operation even in tight spaces
- 8 Functional safety and security
- 10 Save energy automatically
- 12 Automatic and contact-free
- 14 Selection and planning criteria

CREATIVE DESIGN

Multiple configuration possibilities

Automatic doors that blend in harmoniously with the architectural design of any building



Synergy based on functionality and design

Gilgen Door Systems combine customised configuration possibilities with the functional needs of convenience and security.

Customised access-configuration for prestige buildings

Are you looking for functional, prestige design? Our automatic door systems can be supplied in many different customised glass, colour and material variants. Angled, curved or flat door designs can be smoothly incorporated into any overall architectural concept.



Possible configurations

Sliding doors

- Single- and two-winged
- Two- and four-winged, telescopic
- Angled
- Emergency-exit function
- Fire/smoke-prevention function
- Break-in resistant design
- Heat-insulated
- All-glass and layered-glass configuration
- Additional solutions

Curved sliding doors

- Various radius dimensions; concave or convex, including circular porch systems
- Emergency-exit function (redundant configuration)

Revolving doors

- Various radius dimensions

Swing-door drive systems

- for both light and heavyweight doors
- Fire prevention

Folding-wing doors

- for use in places where space is tight
- Emergency-exit function (redundant configuration)

AUTOMATIC OPERATION EVEN IN TIGHT SPACES

Small installation width – big efficiency

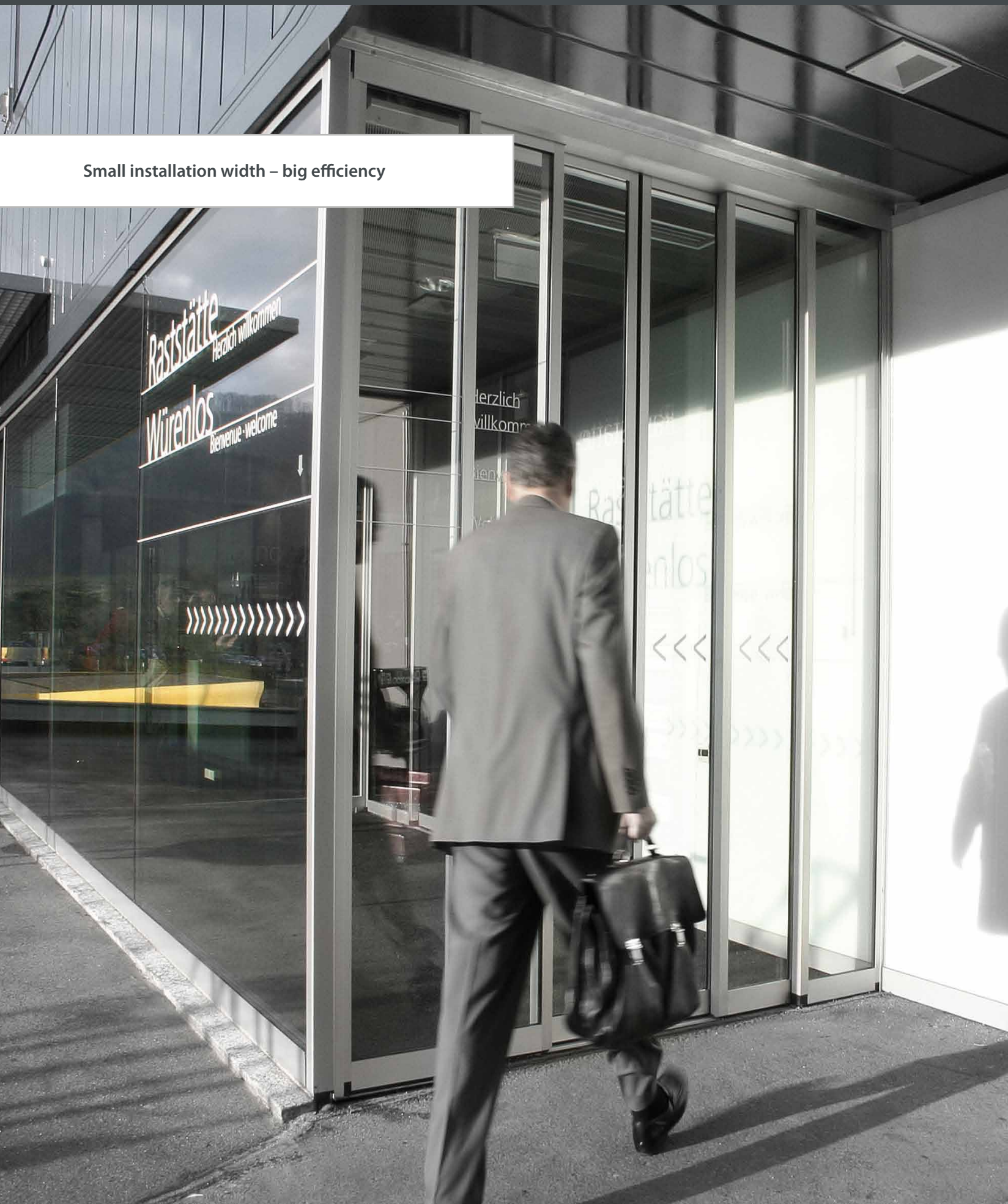

Lack of space need not rule out convenience

Gilgen supplies automatic doors designed to maximise width of access, even when space is tight.

Convenient solutions for all structural situations

The wide range of products supplied by Gilgen Door Systems allows automatic solutions to be incorporated into any door design. Matched to virtually any type of structural situation. Flexible door systems with a wide range of functions ensure user-friendly access at all times.



Swing-door drive system

- Manually operated swing doors can be automated even after installation. Trouble-free opening and closing improves access and makes life easier for users.

Drive unit for telescopic sliding doors

- This solution is ideal for situations where a wide opening-width is required, but where the structural layout prevents the use of wide door wings.

Folding-wing drive system

- The folding design saves space. Gilgen folding-wing doors offer you maximum access widths with minimal system dimensions.

FUNCTIONAL SAFETY AND SECURITY

Gilgen automatic doors offer both convenience and the safety and security required in an emergency.

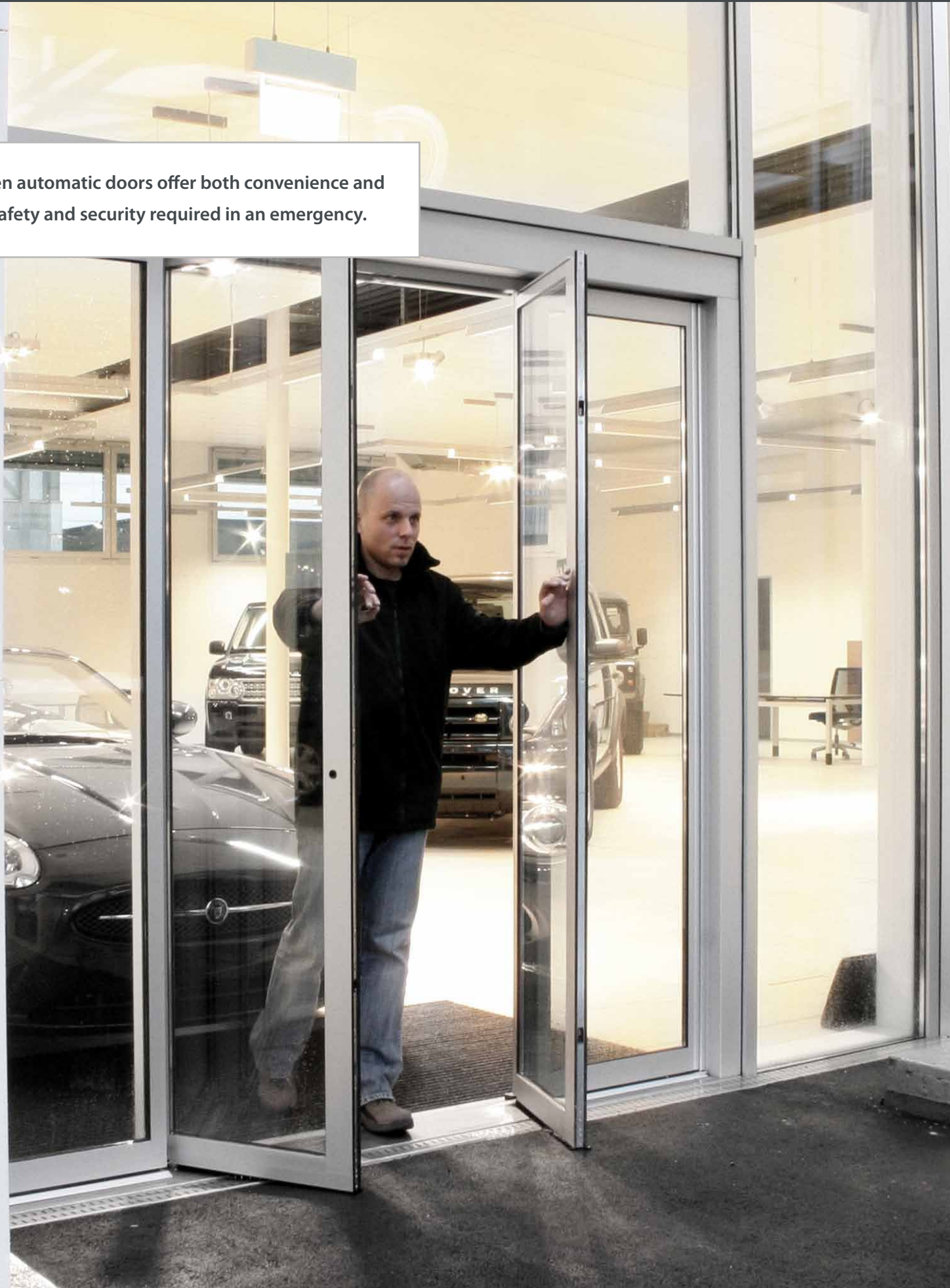

Convenient for everyday use – reliable in an emergency

Reliable protection from smoke and fire and a safe emergency exit/rescue access. Our versatile range of doors offers the right solution for any situation.

Gilgen automatic doors meet the highest quality, safety and security specifications. Our tried-and-tested doors with extra functions increase the range of applications. Automatic emergency exits and fire-/smoke-proof doors offer convenience for everyday use, while fulfilling legal requirements in the event of an incident.



Smoke-inhibiting automatic sliding door

- If a smoke alarm is activated, the door closes to prevent the smoke from spreading to the rest of the building. The door can be operated with an EMERGENCY OPEN button in the event of an incident.

Automatic fire-safety door

- True to our “three door-functions in one” concept, our automatic sliding fire-safety door is, simulta-

neously, a convenient pedestrian-access point, a flame-resistant fire door and a reliable emergency escape route.

The multi-functional SLX Break-Out door system

- Designed to provide convenient automatic access in day-to-day situations, and a safe exit for occupants and easy entry for emergency services in the event of an incident.

Redundant automatic doors for emergency exits and rescue access routes

- Redundant door systems for automatic opening of the emergency exit are equipped with a primary and a secondary system. The continuous monitoring of the components as well as the use of redundant radar motion detectors ensure that, in case of emergency or dysfunction, the door is automatically opened in order to release the escape way.

SAVE ENERGY AUTOMATICALLY



Reliable prevention of heat-loss

Reduced opening and closing times generally reduce the amount of air exchange, thus cutting down on energy loss.



The entry system with added energy-efficiency

The Gilgen PSW < green wings > profile system adds another dimension to environmental awareness. The Gilgen PSW profile system provides, in combination with Gilgen SLX or SLA drive units, a full range of tried-and-tested, heat-insulated automatic doors.

Energy-saving automatic door

The Gilgen heat-insulated automatic sliding door with PSW profiles reliably protects the building with low U-values in order to prevent loss of energy, leading to an improvement in the building's overall energy balance. This is a benefit with a future:



Gilgen PSW: The entire system has been tested and certified by the ift Rosenheim and TÜV organisations

- "U"-value rating
- Low air-permeability
- High resistance to driving rain
- High wind-load capacity
- User safety
- Emergency exit (redundant configuration)



Modern building frontages, let down only by entrances with conventional, non-thermally-insulated profiles = unnecessary loss of energy.

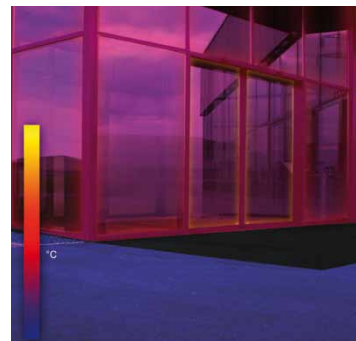

The Gilgen PSW profile system provides the same advanced technology for both frontages and entrances, with energy-savings of up to 50%, depending on the design of the entrance.



AUTOMATIC AND CONTACT-FREE

Barrier-free access

If your hands are not free for any reason, our automatic sliding door provides contact- and barrier-free access.



Unobstructed – Convenient – Hygienic

Freeing up the way automatically.

Automatic benefits

Highly-reliable Gilgen automatic drive units provide trouble-free access from one room to another. Contact-free, convenient and hygienic.

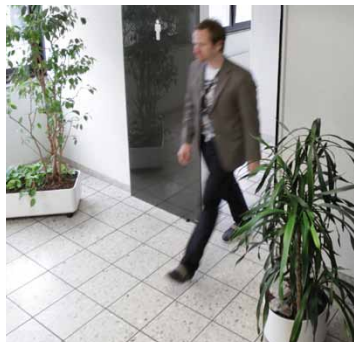

Barrier-free access

Barrier-free access is the key to ensuring that disabled individuals and persons of limited mobility participate in the normal life of society. Barrier-free construction is not just designed to benefit disabled persons and the elderly, but also those experiencing temporary difficulties, such as parents trying to deal with small children and prams, or persons with large items of shopping or mobility-aids, etc.

Health and hygiene

The contact-free opening of doors fulfils the very strictest hygiene regulations. Infections are often spread via direct contact with door-handles. Gilgen automatic doors can make access to toilets, for example, virtually bacteria-free.

User-friendliness

Open up doors for your visitors. Provide a friendly reception based on ease and simplicity of access. Whether users are loaded with luggage or shopping, or trying to keep children in order, automatic doors ensure that each visitor enjoys unobstructed, contact-free access. Automatic doors improve freedom of movement – thereby offering a better quality of life.

SELECTION AND PLANNING CRITERIA

Choose the right automatic solution for your needs.



The right pedestrian-access

- Ideal
- Suitable
- Suitable under certain conditions

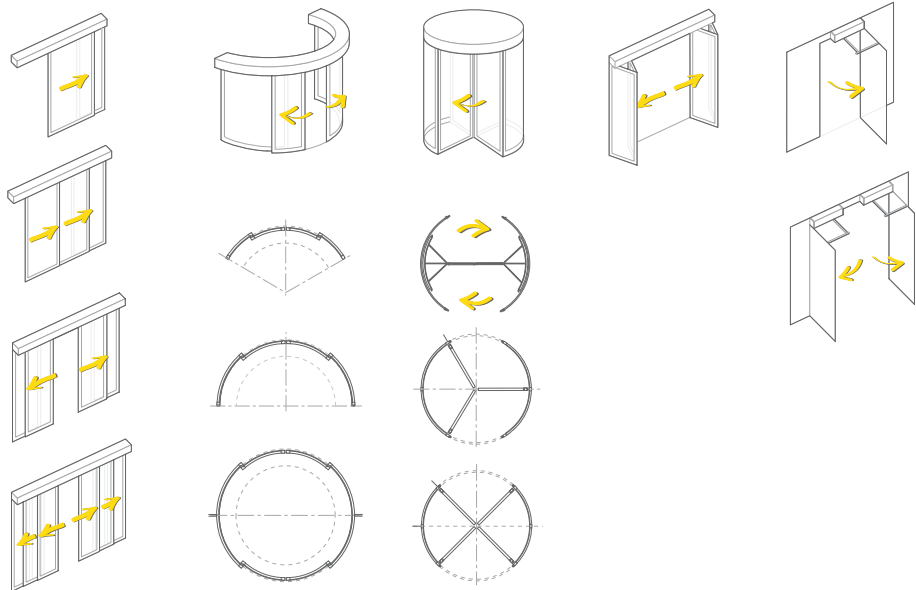

	Sliding doors	Curved sliding doors	Revolving doors	Folding-wing doors	Swing doors
Optimum pedestrian-flows					
User-friendly, barrier-free construction	●●●	●●●	●●	●●	●●
High frequency, flexibility	●●●	●●●	●●	●●	●●
Subsequent automation					●●●
Design and creativity					
Style, presence, material	●●	●●●	●●●	●	●
Transparent configuration	●●●	●●	●●	●●	●●
The dynamic element	●●●	●●●	●●●	●	●
Functions and added value					
Fire prevention	●●●				●●●
Emergency exit/rescue access	●●●	●●	●●	●●	●●●
Smoke control	●●●				
Stops/reduces draughts	●●	●●	●●●	●	●
Access, safety, security and organisation					
Property protection, locking	●●●	●●●	●●●	●●	●●●
User protection	●●●	●●●	●●	●	●●
Installation dimensions					
Access width	800 — 4000 mm	∅ 1000 — 2600 mm	∅ 2000 — 4800 mm	800 — 1600 mm	700 — 2800 mm
Weight of door wing	max. 2 × 150 kg 1 × 150 kg 4 × 60 kg	max. 2 × 120 kg		2 × 70 kg	250 kg Depending on wing size

PLAN WITH US



Your notes

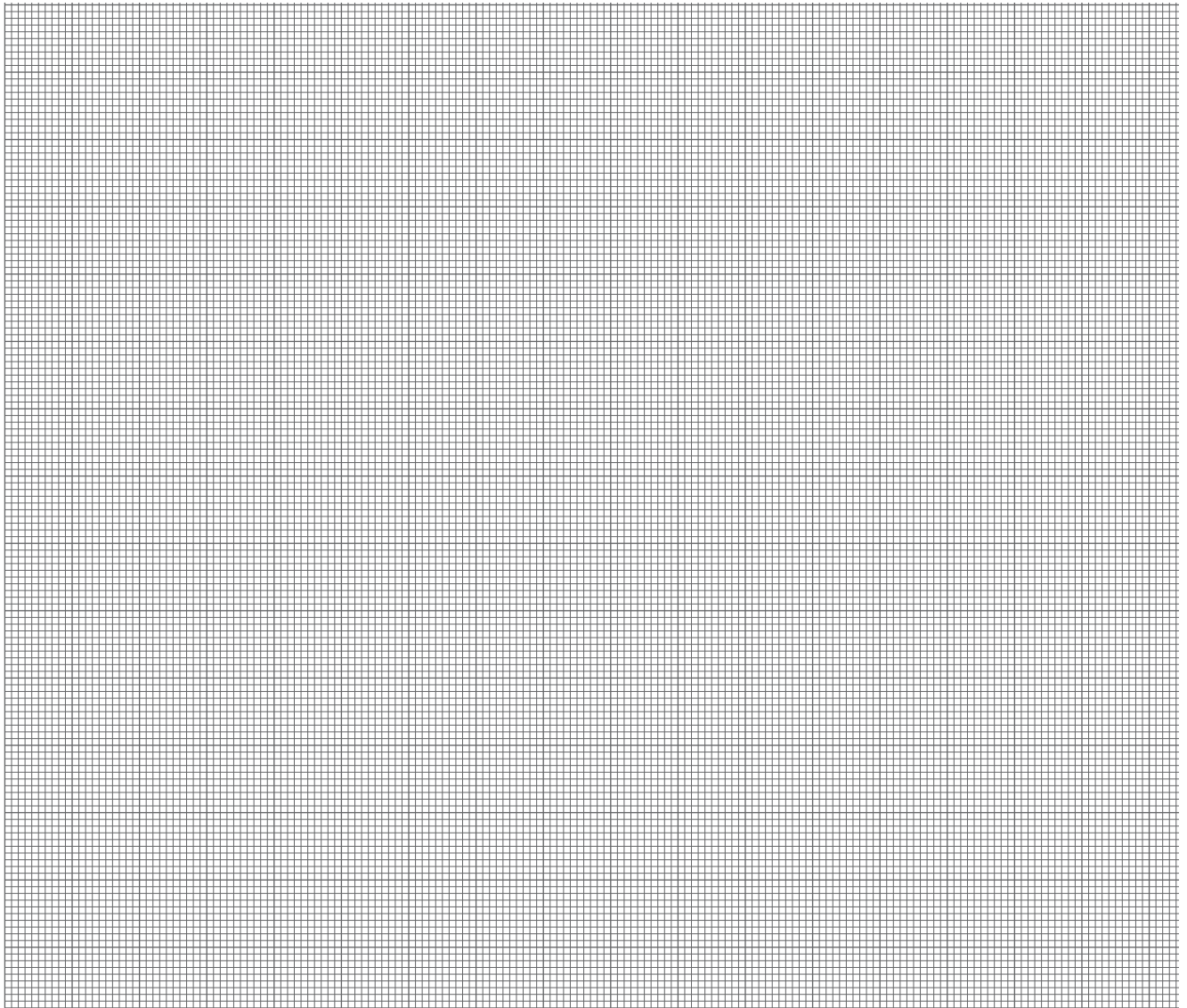

Your notes

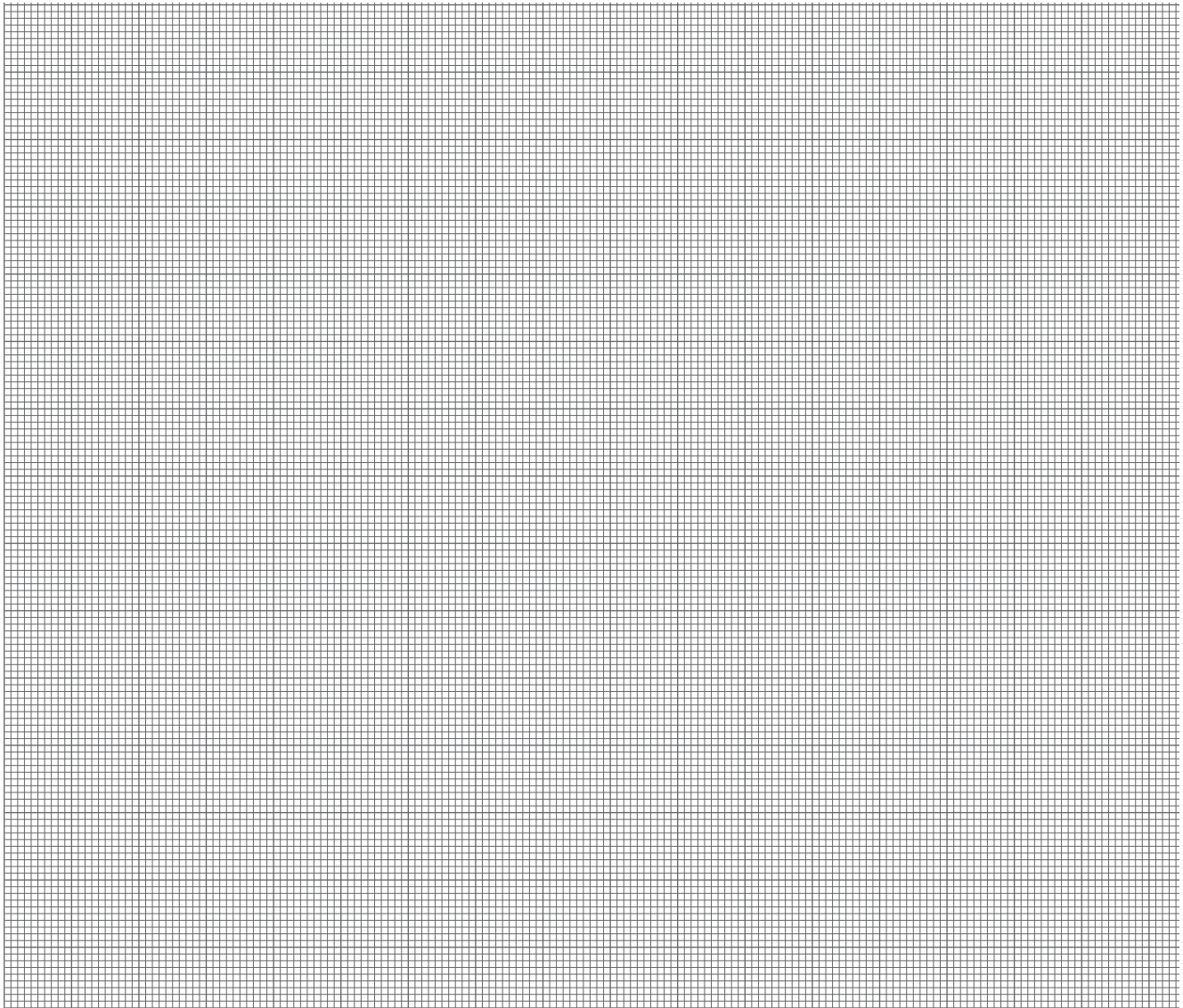

Hauptsitz
Gilgen Door Systems AG
Freiburgstrasse 34
CH-3150 Schwarzenburg
Tel. +41 31 734 41 11
Fax +41 31 734 43 79
www.gilgendoorsystems.com

Hauptsitz Vertrieb Schweiz
Gilgen Door Systems AG
Untermattweg 22
3027 Bern
Tel. 0848 80 44 88
Fax 031 985 36 01
www.gilgendoorsystems.ch

Gilgen Door Systems AG
In der Au 5
CH-8406 Winterthur
Tel. 0848 80 44 88
Fax 052 268 90 10
www.gilgendoorsystems.ch

Gilgen Door Systems AG
Route des Avouillons 30
CH-1196 Gland
Tel. 0848 80 44 88
Fax 022 999 60 80
www.gilgendoorsystems.ch

Gilgen Door Systems Germany GmbH
Münchener Strasse 22
DE-64521 Gross-Gerau
Tel. +49 61 52 92 52 60
Fax +49 61 52 92 52 70
www.gilgendoorsystems.de

Gilgen Door Systems Austria GmbH
Concorde Business Park 1 / E / 1 / 4
AT-2320 Schwechat
Tel. +43 17 06 58 66
Fax +43 17 06 58 56
www.gilgendoorsystems.at

Gilgen Door Systems France S.A.S
21, rue Alexis de Tocqueville
Silic 5 - Immeuble Ampère
FR-92182 Antony Cedex
Tel. +33 1 46 66 66 80
Fax +33 1 56 45 29 66
www.gilgendoorsystems.fr

Gilgen Door Systems UK Limited
Halesfield 4
GB-Telford, Shropshire TF7 4AP
Tel: +44 870 000 5252
Fax +44 870 000 5253
www.gilgendoorsystems.co.uk

Gilgen Door Systems Italy srl
Via Andrea Costa, 6
IT-40013 Castel Maggiore (BO)
Tel. +39 051 70 49 45
Fax +39 051 63 25 099
www.gilgendoorsystems.it

Gilgen Door Systems Spain
Tel: +34 93 59 07 19 4
Fax +34 93 59 07 19 4
www.gilgendoorsystems.es

Gilgen Door Systems (Suzhou) Co. Ltd
Block No. 28, Unit A
Suchun Industrial Square
428 Xinglong Street
Suzhou Industrial Park
CN-215125 Suzhou
Tel: +865 12 62 83 62 28
Fax +865 12 62 83 63 38

Nabtesco Gilgen (Hong Kong) Limited
1121 - 1123 Hollywood Plaza
610 Nathan Road
Monkok, Kowloon
Hong Kong
Tel. +852 35 80 77 08
Fax +852 37 41 09 19